

# EXPRIMIDOR T34R

Para mayor información: Tel. 5537 7015 / 5537 6008 · www.tapisa.com.mx

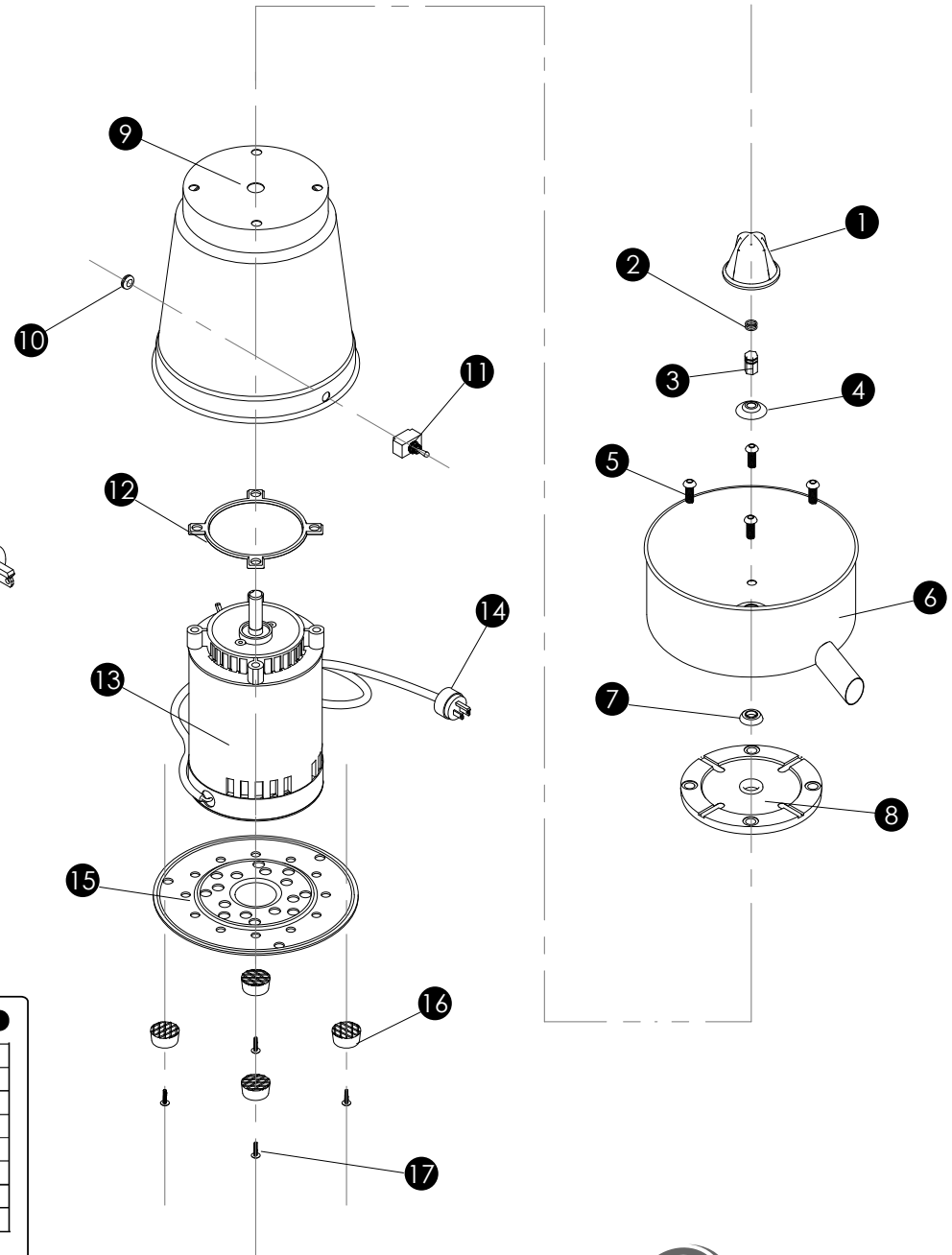
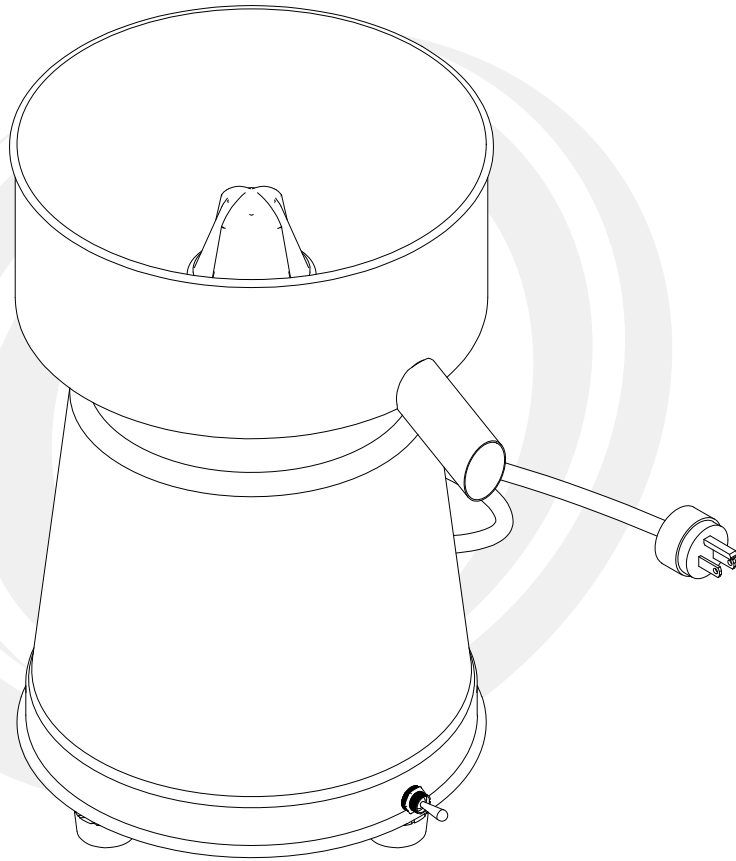

No.	DESCRIPCION	CANT	CODIGO
1	PERILLA	1	10101
2	ORING	2	10103
3	HEXAGONAL INOXIDABLE	1	R-20102
4	BOTAGUA INOXIDABLE	1	20103
5	TORNILLO INOXIDABLE 3/8"	4	20104
6	COLECTOR RECTO INOXIDABLE	1	20101
7	RETEN POLIURETANO	1	20105
8	DISCO DRENAJE	1	20107
9	CUBIERTA DE MOTOR	1	R-30101

No.	DESCRIPCION	CANT	CODIGO
10	PASA CABLE	1	30106
11	APAGADOR	1	34103
12	UNION DE MOTOR	1	30105
13	MOTOR	1	35102
14	CABLE TOMACORRIENTE	1	30104
15	TAPA MOTOR	1	40101
16	PATAS DE HULE	4	40102
17	TORNILLOS DE PATA	4	40103